

**Enclosure Design of Electronics Equipment**  
**Prof. N V Chalapathi Rao**  
**Department of Electronic Systems Engineering**  
**Indian Institute of Science, Bangalore**

**Lecture - 29**  
**Ready made enclosures**

So you have a data sheet here. This data sheet again like a pdf you can enlarge it and all the details regarding what are the sizes seen that know, what all you can do with it are there and this is what I wanted to tell you in the earlier when it is not there.

(Refer Slide Time: 00:17)

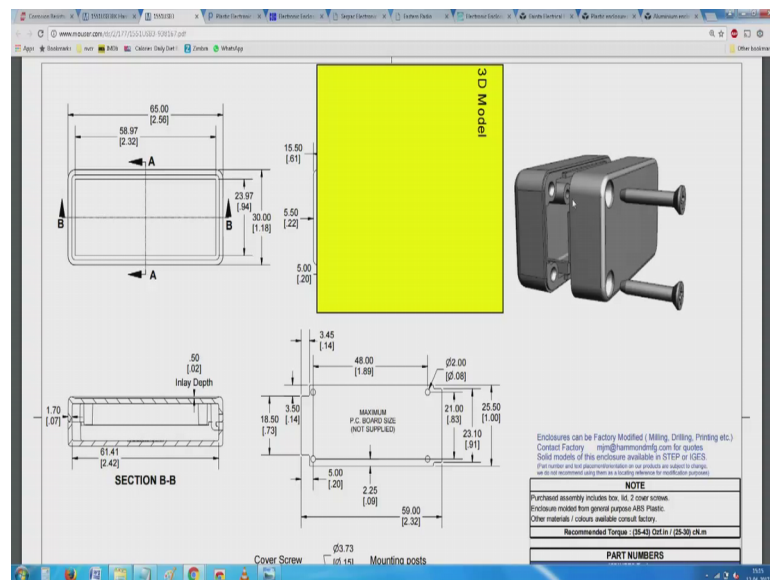

This here you can probably download a full fledged 3D model which is compatible with more start arduous products, most mechanical products, similarly the Salt and Siemens solid edge solid works rhino and a large number of this things understand this models. I do not have a very a proper a program which I can used to open it hence I cannot open it.

(Refer Slide Time: 01:17)

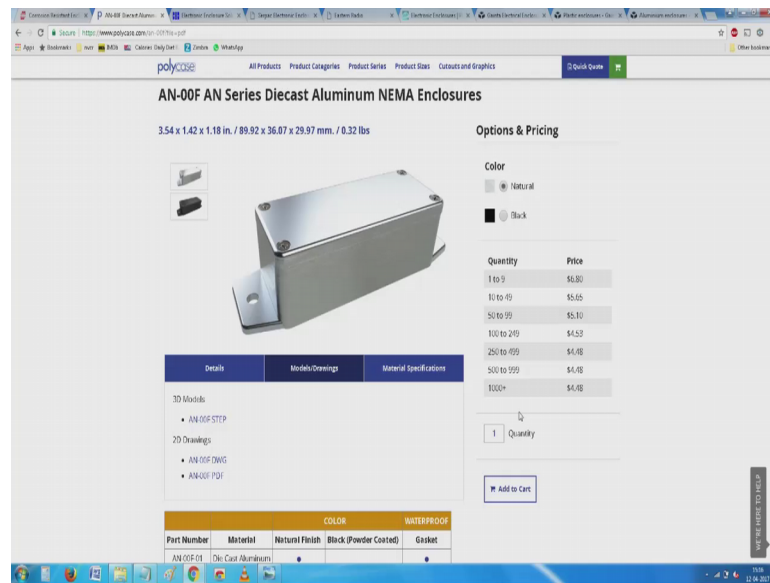

Now, you see here important thing about pricing about lifecycle information is also given here, saying how long will they maintain it in their data sheet. I will now close here I will see if I can go to other manufactures you see here we have large number of sizes you can shop by size then there are lot of outdoor catalogs. So, if you go for those outdoor enclosures you have I will see whether I can open one of these things and see if it still works it is trying to download the engineering drawing.

So, any detail you want is already there and then you see here while this is listed automatically here while this listed automatically here you still need to negotiate once you negotiate you have this beautiful thing here then there are something related to the type of models you have. So, I do not know I am not familiar with this step format I expected it is something which most 3D programs well open it automatically; it may be a little like the igs and then you see material is given here something equally related to saying what are all the materials they use for the manufacturing.

This is where since we are not experts in metallurgy or we are not experts in application of particular fabrication process with the known metallurgy we can always look up their thing here again sorry for this thing.

(Refer Slide Time: 03:22)

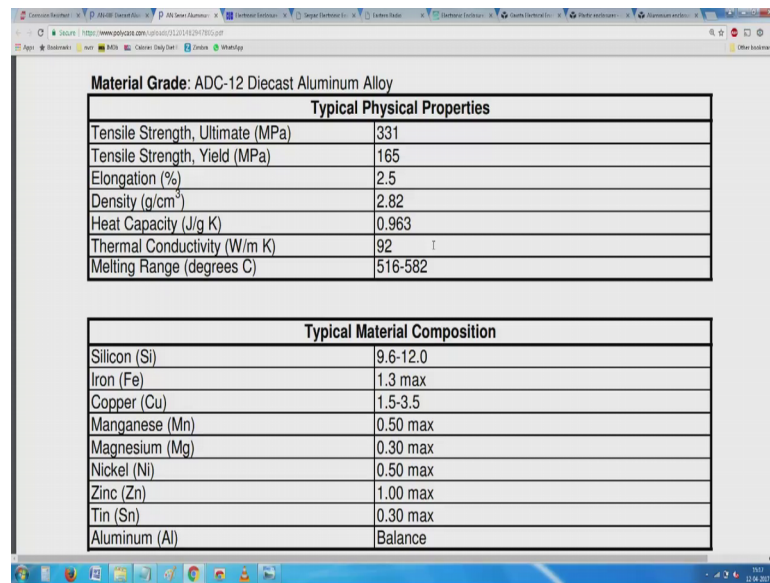

**Material Grade: ADC-12 Diecast Aluminum Alloy**

Typical Physical Properties	
Tensile Strength, Ultimate (MPa)	331
Tensile Strength, Yield (MPa)	165
Elongation (%)	2.5
Density (g/cm <sup>3</sup> )	2.82
Heat Capacity (J/g K)	0.963
Thermal Conductivity (W/m K)	92
Melting Range (degrees C)	516-582

  

Typical Material Composition	
Silicon (Si)	9.6-12.0
Iron (Fe)	1.3 max
Copper (Cu)	1.5-3.5
Manganese (Mn)	0.50 max
Magnesium (Mg)	0.30 max
Nickel (Ni)	0.50 max
Zinc (Zn)	1.00 max
Tin (Sn)	0.30 max
Aluminum (Al)	Balance

You see here most of the properties are given here is a little difficult for us to interpret this information without the proper understanding about and what you see here a lot of it know including basic yield strength then various types elongation and then very important thing here is this thermal conductivity and queue the heat holding capacity are all mentioned here. So, if you have this you can now select the type of material like to use and what you want to do with it and for what is the application has to be done and so on.

So, here basically it looks like is an aluminum case, but has traces of the silicon and I mean sorry large amount of silicon composition. So, it is aluminum silicon case which will make you make this very very suitable for our application. So, it is not for us to copy or anything it is for us to understand how it is.

(Refer Slide Time: 04:48)

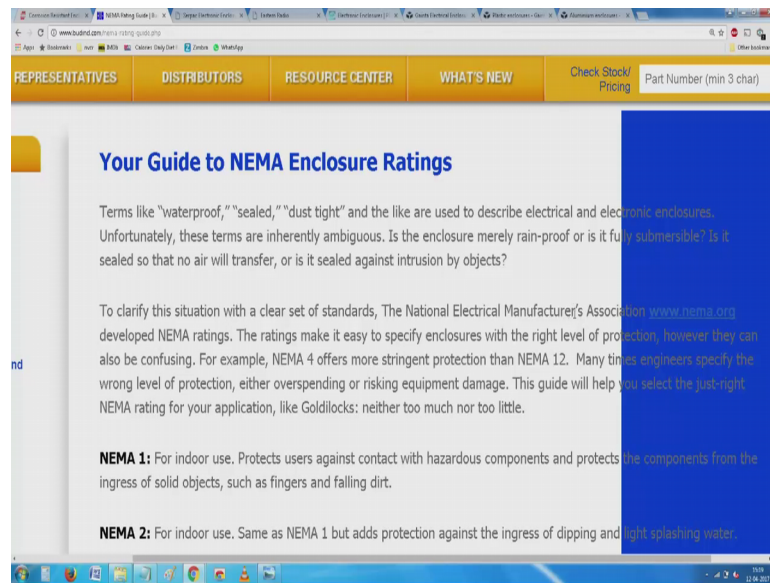

So, as we go on see here beautiful this catalogs this is where know the word and is a standard you seen here very very important thing is water proof dust tight are used to describe electrical this unfortunately this terms are ambiguous the enclosure is merely rain proof or is fully a submersible.

Similarly, a set of standards the national electrical manufacturers I told you in the earlier thing NEMA gives these particular things, you are saying NEMA 1 2 3 4 and then x and so on.

(Refer Slide Time: 05:33)

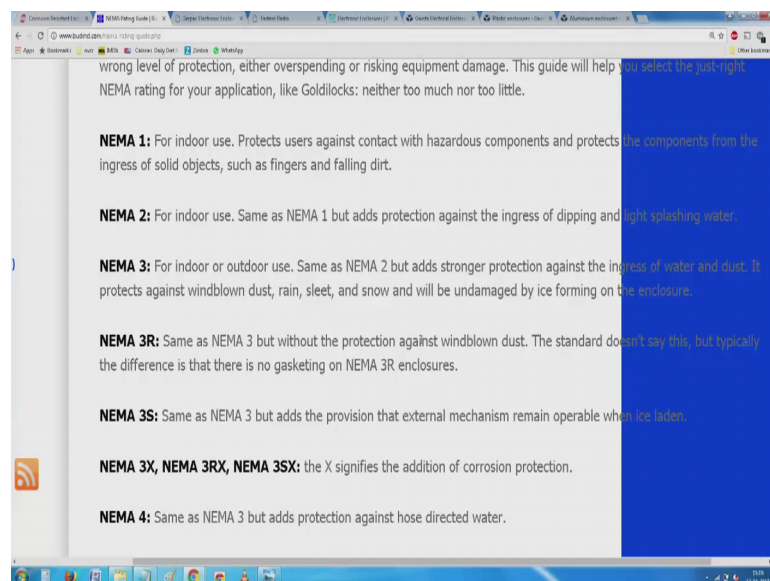

A little related to this is the IP classification saying the index of protection classes meant for other type of equipment where you have a 2 and 3 number system all of us are familiar with probably the IP 55 which is commonly used and then we have IP 56, IP 66 and finally, IP 67.

If you go through this in detail you will notice that it is not as simple as just I trying to buy small bucks you have seen this know, if I suggest you read go to their this website and find out to see what is a there are IP number designations, the smallest is open chassis equipment.

(Refer Slide Time: 06:08)

First Number	Protection From Solid Objects	Second Number	Protection From Water
0	No protection	0	No protection
1	Protected from solid objects over 50mm	1	Protected from vertically falling drops of water
2	Protected from solid objects over 12mm	2	Protected from direct sprays of water up to 15 degrees from vertical
3	Protected from solid objects over 2.5mm	3	Protected from direct sprays of water up to 60 degrees from vertical
4	Protected from solid objects over 1mm	4	Protected against sprays from all directions - limited ingress permitted
5	Protected from dust-limited ingress	5	Protected from low pressure jets of water from all directions - limited ingress permitted
6	Totally protected from dust	6	Protected against strong jets of water - limited ingress permitted

Sometimes if we make a power supply and those things if you remember in the beginning I have showed you one panel building, so you have panels in which these equipments all mounted the outside big enclosure is fully protected. So, in this case generally IP 2 0, IP 1 0 all this things mean that it is a buck switches generally protected it is a open, but is expected to be used one more time in another equipment. So, most of the small sub assemblies and all including the PCBs and all what you are talking about are probably taken from here.

(Refer Slide Time: 07:20)

number that meets or exceeds a particular NEMA rating.

NEMA	IP
1	10
2	11
3	54
3r	14
3s	54
4 and 4x	55
5	52
6 and 6p	67
12 and 12k	52
13	54

Further if you go down NEMA to this the cross verification is been given here NEMA 46 correspond to 55, 55 is it not actually fully submersible equipment, the only submersible explained or probably 6 6 p here, in the IPs 66 and so on. You need to take a stand on this here saying even if you have to make something a few numbers of would you like to go here or would you like to make your own enclosures.

So, my own personal calling this it is better that we concentrate on the electronics and the functionality and not so much on the enclosure design. So, in this particular lecture series is how to make equipment design that is packaging of electronic equipment at a system level I feel you should study this in detail. And given example as one of our students has made the traditional what you call colored fountains here it is called a musical fountain.

So, need not have to go and search much for it, the actual basic the fountain parts and all have been installed by somebody who is good at handling all the plumbing and things, but the control the walls you have electronics his first of samples were made using these things. Again once again that lights and all are supplied by a supplier lights have a different wave dealing with it, but you see any light; obviously, have something on which you know the light comes out from then you have something for alignment.

So, there is a case around it and then there is somewhere you need to give power to it and then whole thing has to go and match with the fountain part of it. The lights are probably

again you know done by another supplier the plumbing anything has been the bend, but the full control of how to activate this various things, how they are cabled some of them are directly submerged equipment just sitting under the water level in a it is not a full fledged what you call I will not call it as swimming pool. But it is a harsh environment you have a large spool and which only the shower heads and then nozzles come out of the water remaining just underneath that you have all this sophisticated sealed equipment going underneath and what cannot be kept there it is still taken out and then kept in a mildly harsh equipment.

So, if you have to have a jacuzzi your house I do not know how they pronounce it, put up with my accent I do not know where you calls a jacuzzi or whatever that is if you have a jacuzzi at home you would not want to beadle at electrocuted, but still it has so many what you call walls which you need to operate there is a button which you know increases or decreases the temperature and their buttons which start the waves or the froth and then there is a button which I expect it dust drains and I do not know what all are there.

One of the first thing you will notice is it is not operated electrically the one you press there often it is just air or hydraulic hose which you as a button you press and then in the wall you have a contactor which is operated by this connecting what you call inert fluid sometimes it is air sometimes it is a liquid. But what you say there or beautiful colored knobs and you know often color changing and all that know that small part of it which is required there is generally low voltage and still has sealed various types of connectors and so on in that.

The main thing which operates or probably you require 6 to around 10 kilovolts heaters inside and then you need pumps which are probably how the order of 2 to 3 hours per and then you need some frothing (Refer Time: 11:54) and all that all of it is still controlled using the small knobs which you press which are controlled, put in a panel in the wall which is control through pipes and through the pipes say there you have a low voltage connection or you have a simple air or water connection.

So, you see this NEMA rating and all that you will see that you have a very large number of data which is available, then I suggest that one needs to read about the progress of

how electronics enclosures came to be seen that know this one of the pictures I was trying to show here, in all that you can think of somebody has thought for you.

(Refer Slide Time: 12:21)



And secondly, while some of these items are listed in the catalog they are there in their blog and all that then may or may not be available in the quantities they want. Sometimes a minimum order quantity will run into a few hundreds and expensive, sometimes the maximum order quantity which they commit and that smooth flow of the items in the pipeline cannot be guaranteed. If you want let us say every month you want say some 2000 of them it needs negotiation somebody has to sit negotiate and see the various terms and then do they expect you to stock and another ultimate thing that can happen is will it continue to be production for your product life cycle. Your product life cycle you may be estimating around 10 years and then they say right now we are coming out of the new series or new technique.

So, we cannot guarantee if you want why do not you buy up a whatever stock you require for your next few years that is where we probably need to look at can we have an alternate source of all these equipments here, you see here.



(Refer Slide Time: 14:25)

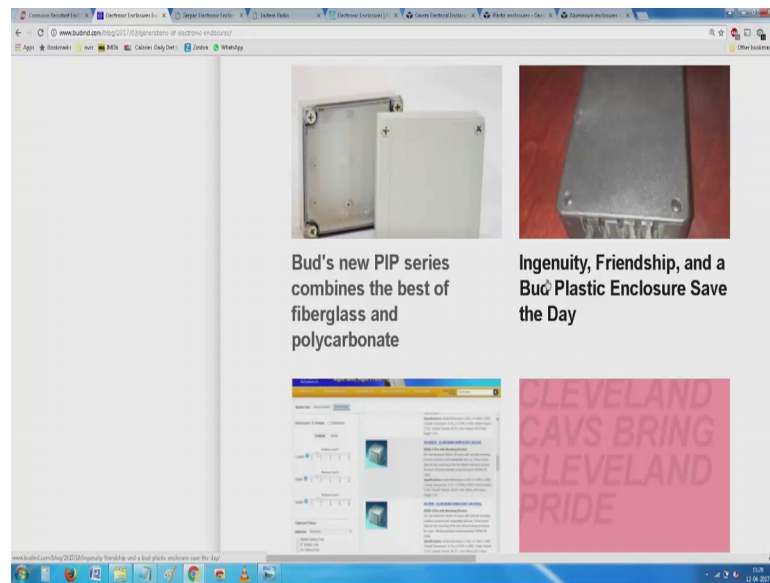

So, so many of this large number of you seen this know it is of course, a small thing about may be a little bit of I will not say sell a bit of making information about their products.

Now, you see here you have the beauty of polycarbonate and fiber glass loosely know both fiber glasses good in its own way as and we have polycarbonate also where do we need to do what. So, polycarbonate has certain advantages one of them is tough tough tough, but it has its own limitations meaning while you can injection mould it and all in some conditions it requires additional control on the thicknesses. Meaning from the injection point to various vent points and the way the materials spreads often this injection in a machines use what is called the submarine gate, sues marine gate.

So, in sues marine gate the material comes in comes out and then finally, when you want to take it off a small pip continues to remain and wherever the dice close we may end up with flash. So, location of the flash location of these pips all still happened to has still controls.

(Refer Slide Time: 15:52)

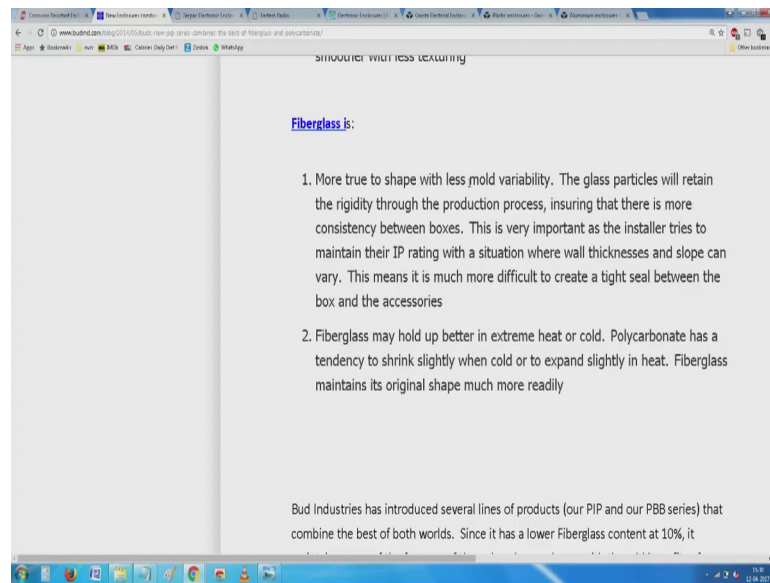

In contrast to this we have this fiber glass which is good anything you want can probably you can make. So, they have given all this stuff is here and so on and all that, fiber glass leads to true to shape with mold variability retain rigidity and so on and so on know, so many other process are there.

(Refer Slide Time: 16:41)

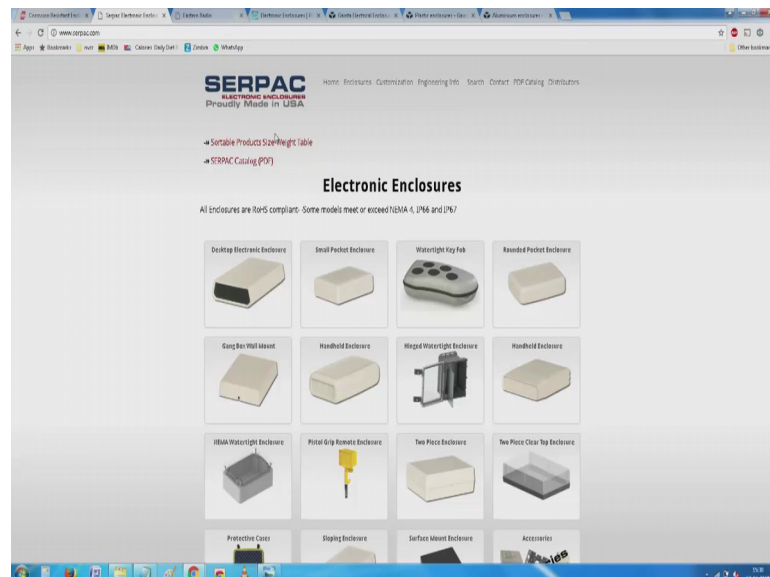

While we take it very easy saying or it is a matter everything is done not long ago, only around 50 years back if you remember all over automobile bumpers where made with heavy metal and in fact, chrome bumper for a car was you know a matter of are saying

there is so much of chrome on the car then over the years they found out that having a chrome bumper you really does not help. I do not know I am not an automobile person, but kindly put up with my value judgment saying eventually everything now has been replaced with glassed flit nylon or some new type of bumpers which have fantastic capability to absorb impacts.

So, if the bumper you by some accident or I will say I should not use any religious thing by some miss up you get into a crush, a lot of the impact is absorbed by the front plastic materials and then the beauty of this is now all type of sensors cameras everything can come built into the plastic impact taking devices.

Next time you have a chance you go through various thing various what you call I expect know information sources and check how things have improved. Same thing has also happened a little in our electronic enclosures.

(Refer Slide Time: 18:19)

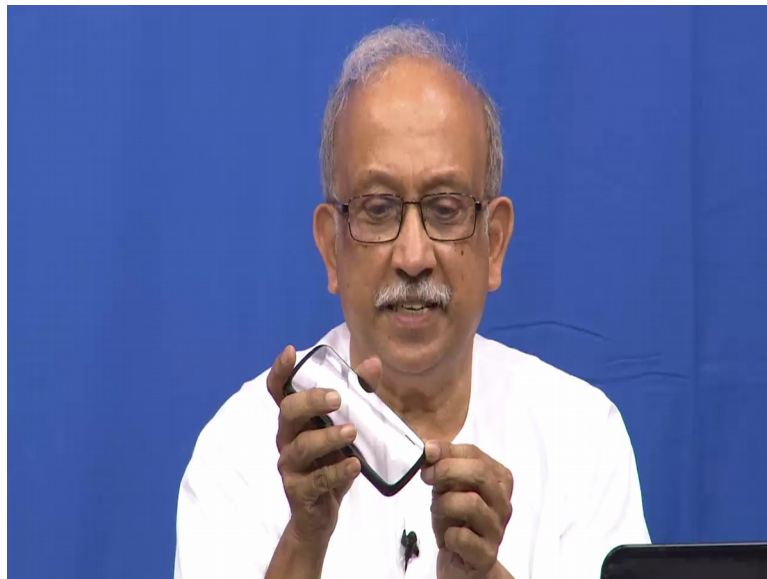

So, whenever we have the corners of any this thing I will give you an example of my mobile you have this corners it just rounded, but also its made with a special material which ensures that some small bumps it can take. And if you can go to our this enclosures you see here that most of the things what you can think of they seem to be about the same among all the manufacturers.

(Refer Slide Time: 18:38)

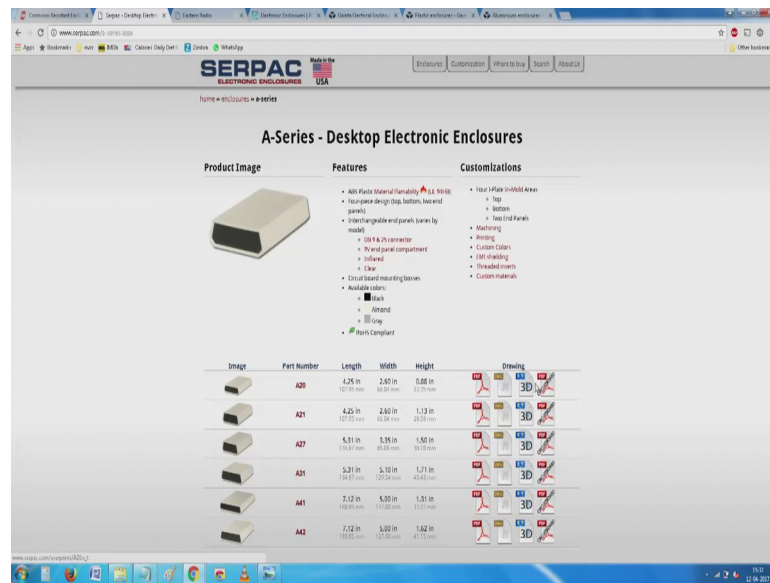

So, at this point now I will see if I can open one of these pdfs drawings, see near, do not have thought of too much of this detail, but several things which I have been talking of earlier are included.

(Refer Slide Time: 18:59)

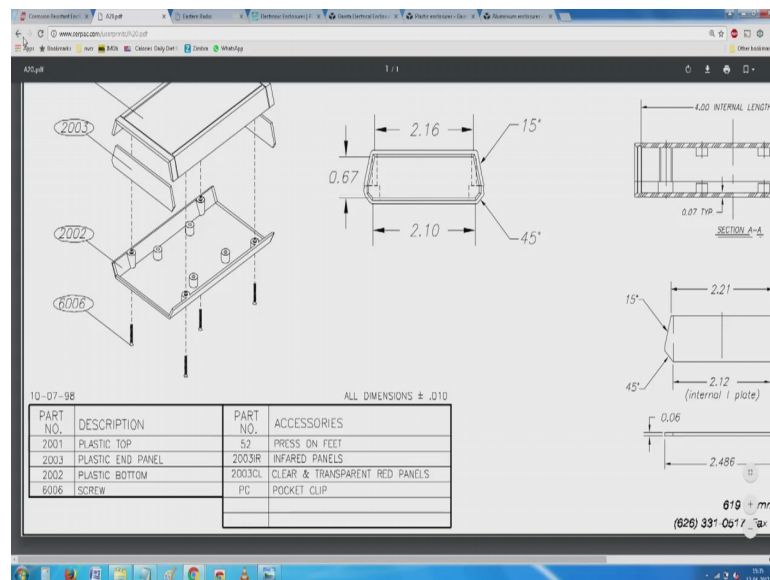

In this these are inches, so I expect know this whole thing is of the order of about an inch 3 quarters of an inch, but to make it look like it looks like you have seen that about one third of the way up from the bottom a bulge has been given. It is not exactly in the middle its counter into you can say if you can put it in the middle we could have

made to identical parts even that variety is available, but in this case they have try to include they have made this bulge a little at the bottom because hardware related to joining these 2 points together you see here we have four fasteners and then there is a top and bottom which will get fixed with the fasteners and then there is a place here for fixing your printed wiring board with all the circuitry.

So, all you need today's probably look at the catalog and then see which one of them is suitable. So, this is a as I said know 3 quarter inch and there is across is a 2 and half inch wide what you call enclosure and length is around 4 inches. So, this is typically a small thing which you can use for any of this small enclosures you see one more thing is we have a 202 and 203. So, we have infrared and transparent and red panels which can be used for intercommunication in case you want to make let us say 2 of the devices talk to each other we can buy one of these things and then you are in I will say you are ready to manufacture things.

(Refer Slide Time: 21:24)



The absolute reality of the material is again see here we have any detail you can think of is probably there including non skid feet and you can keep on building on these enclosures as you like. So, I will take one of the things which you know it is possible for you are seen this, watertight handled key I am not able to understand what fob means as we go along we will understand what it is.

So, you see here know anything you can think of somebody has already thought about saying we make a small enclosure. So, good example like can think of is probably I am carrying it yes my car keys are with me; so if you have to make some new concept for your car, seen this.

(Refer Slide Time: 22:44)

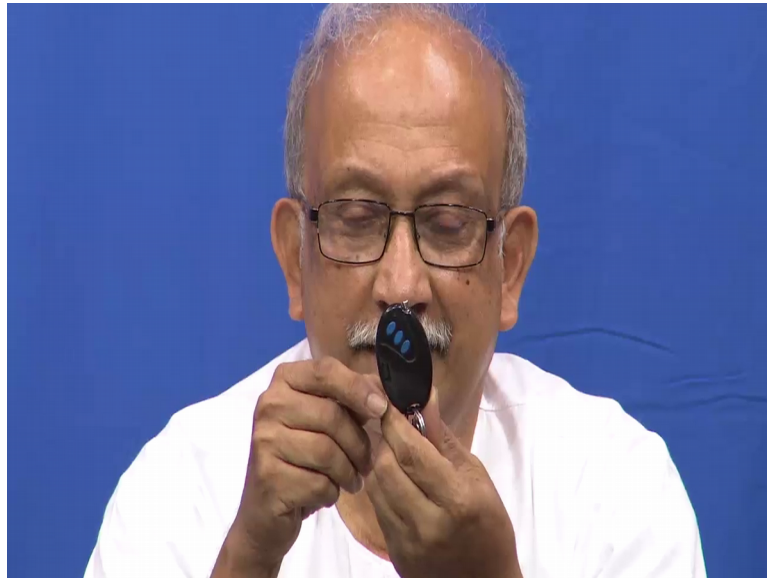

I am not very sure if actually it is company themselves have made this, I do not think this company they in and in fact, this is a not an original remote control for my car. All of these are available probably if the remote control comes with the car, but then you are trying to make some other device at home including a remote to find where you have lost your remote or a really a really universal remote which learns from every remote you have in the house by which you can control may be the blinds or sheds and then you can control probably your audio system or in my case I wish I found a remote which can control the gain of my hearing gain all at one go, not yet made it is just a I am sure it can be made.

So, you see things like this you can always go and then try to make use of this various types of enclosures and get your first button ready. Say you see here I will just try to make it a little bigger and you can see the features they have listed here, very interesting thing. If you are looking for all along first thing is ergonomic design.

(Refer Slide Time: 23:50)

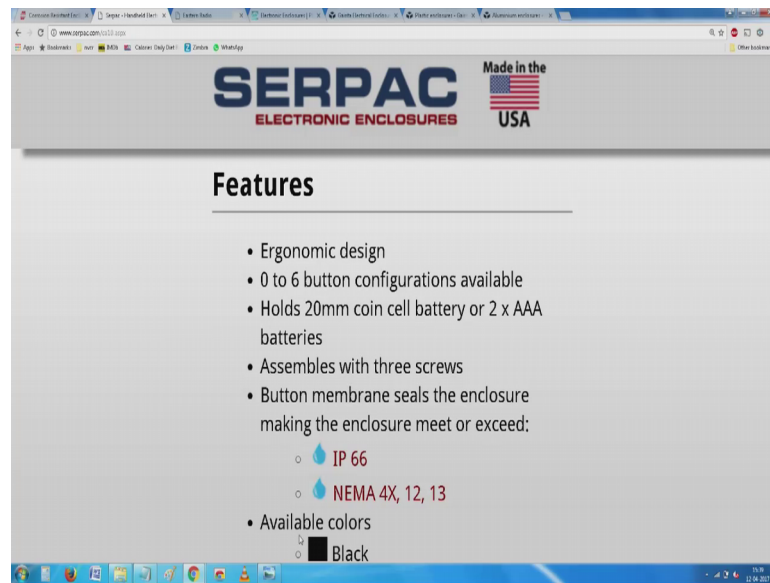

So, ergonomic design; obviously, you know that you know how easy it is use, but then opposite are know how some of them should not be then otherwise the whole concept of a pocket call would not have come you put it in your pocket and unwittingly some door should not be opened. So, a various types of what you call features built into it something the number of buttons another you are seen here you have this coin cells. So, coin cell is something you know generally it looks a little like your coin. So, generally the combination is they will put the height and the diameter to describe these things.

So, 10-20 I am sorry 2 0 0 5 and a 2 0 1 0 refer to diameter, they are all available up to 25 mm into 9 mm and so on, in the extreme right you have the point torch cells. You have the a 4 A, triple A, double A and then you have half double A, 3 quarters double A and all sorts of combinations. And you see here something which I enjoying scene button membrane seals the enclosure, what you see here is they may not be discreet buttons this whole thing may be a silicon pad on which the buttons stick out and then you see here a small feature also base given, so that in the darkness I can say which is the front which is the back and then I can also figure out which one to press like this.

And after putting that membrane underneath and then if there is a lip underneath this groove and it is assembled in place together while it is not a fully submersible equipment, it is half way through they have given IP 66 is the, IP 66 does not mean

permanently you need it under the underwater, but accidentally should it fall down a bundle what you call a pull or a puddle in water nothing will happen.

So, advantage for us is you see here we have colours and printing (Refer Time: 27:08) anything you want.

(Refer Slide Time: 27:06)

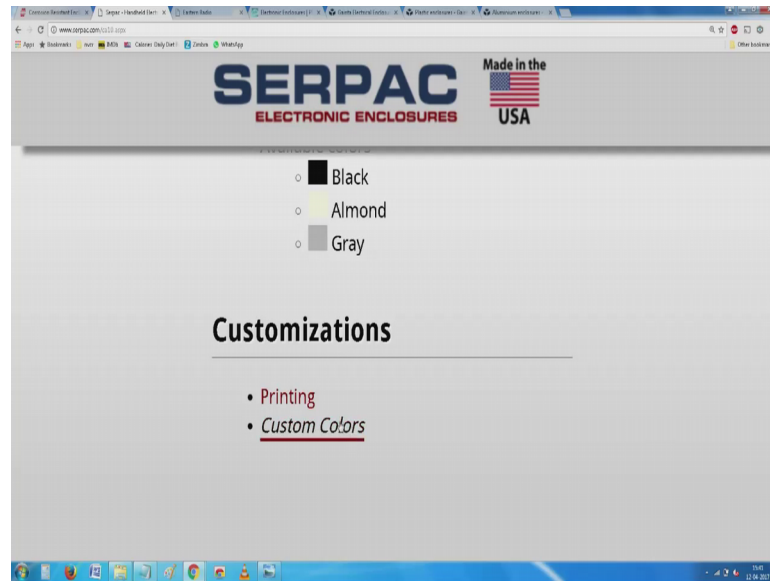

This is where (Refer Time: 27:12) keep coming back saying obviously you have desktop enclosures, you have water type key what you call boxes, then a wall mount gang box meaning you have some a lot of you know things which you try to keep on the wall and slowly we are coming into watertight hinged enclosures.



(Refer Slide Time: 27:14)



Advantage of a watertight hinged enclosure is you put it on the wall and then you can open the cover and then you see here it is called a glass enclosure glass thing. So, you can still continue to have some indications and some type and then full access to various things.

You see here even very very interesting obviously, things you know oh I wish I made it type of things it is of course, one layer transportation case.

(Refer Slide Time: 28:01)

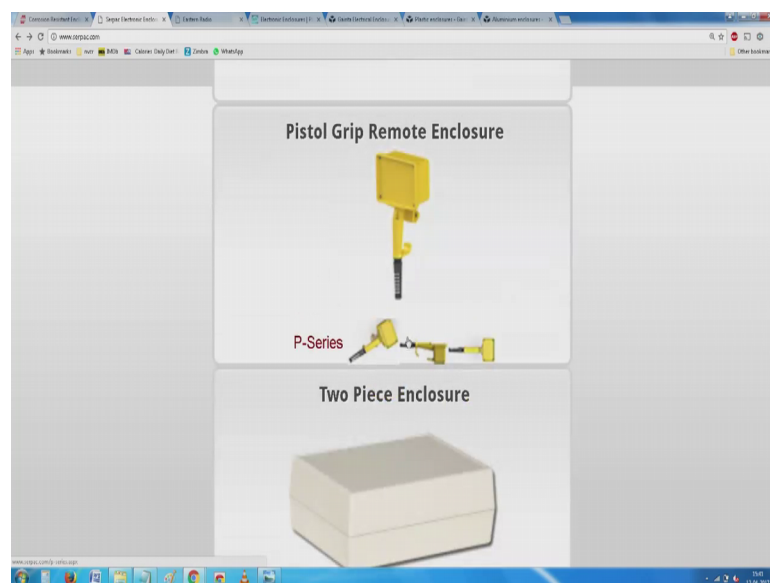

This I will show you, this slopping enclosure from other manufacturers. Then something which was very very interesting is a large number of accessories.

(Refer Slide Time: 28:21)

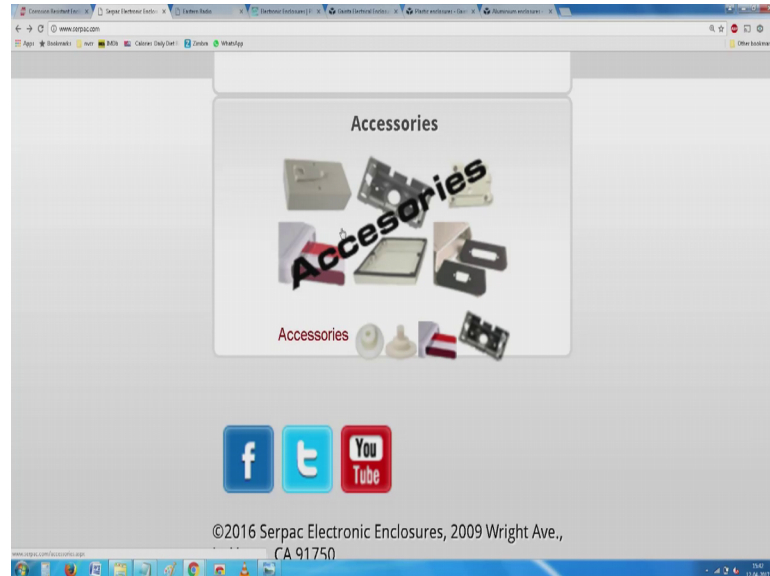

How do you mount things and then can even an access to an access card here and so on.

(Refer Slide Time: 28:31)

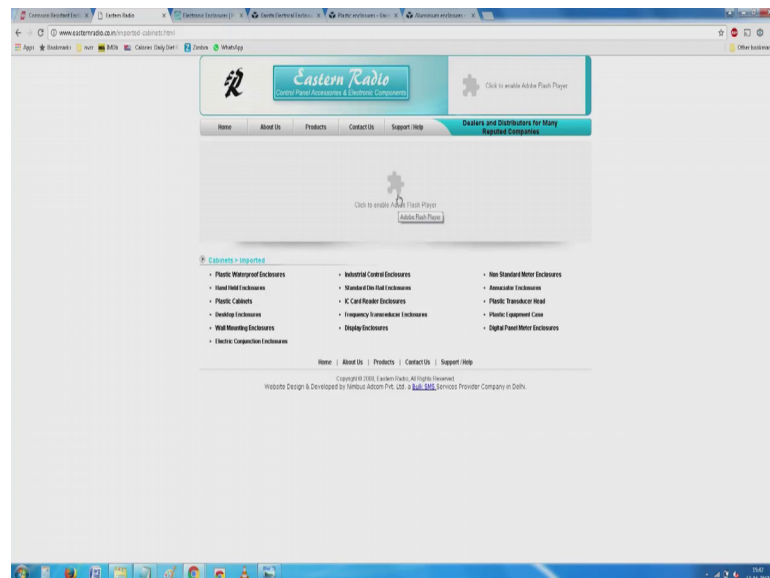

These eastern radios are out of interest for the local suppliers I thought I would like to; this is a supplier who supplies this things in India. I do not need to try that first time you remember.

(Refer Slide Time: 28:45)

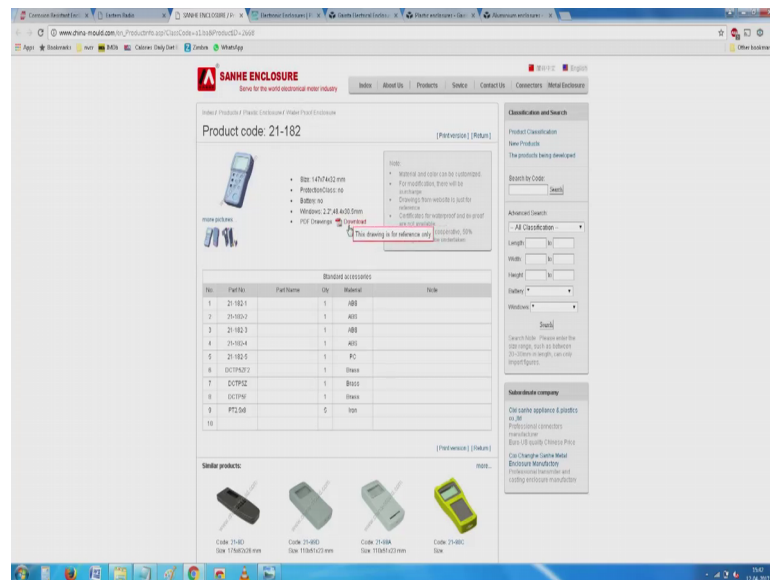

I gave you an exercise why do not you make a handheld meter start a cardboard box cut it and then try to put things and so on.

(Refer Slide Time: 29:04)

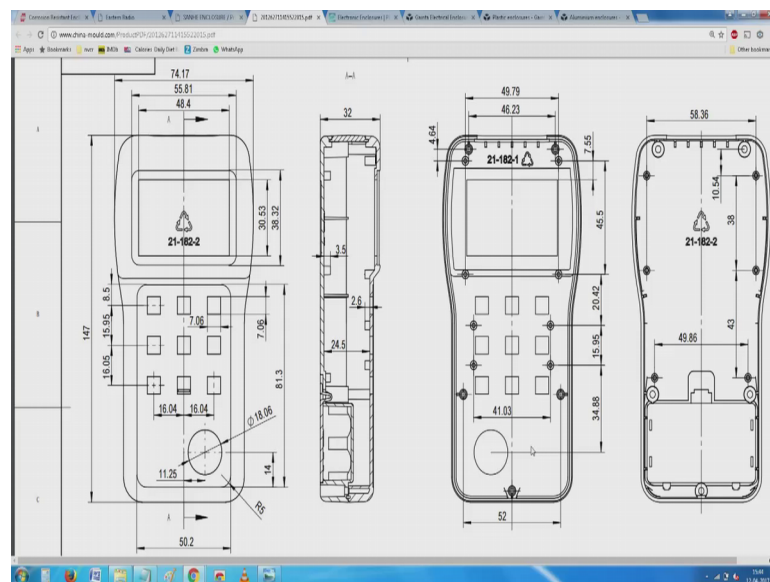

While make it you need to know what is the total load pack available and all that if you can go through this standard enclosure catalogs we will see that miracles sly these things into fit your requirements, seen that. So, it is good 75 mm is about this much 3 digits wide this is 3 inches otherwise 75 millimeters.

So, conveniently it can be held here nicely and then you see the lenses length is about 147. Let us say that us around 5 inches longs. So, something which neatly sits and then you also have a one and a quarter inch thick 32 mm height, it is exactly what we wanted. Fine, I mean it will life cannot be better than this you see here something else, it has a beautiful place for putting your power supply.

So, depending on what you would like to do it is possible for you to power it up using perhaps to double layer cells and then probably you can even make them rechargeable if you have necessary connectors and all. All that it needs now is a little bit of thought on where will you mount any of this your necessary hardwares.